



2430G

**Alicates ERGO™ de boca
semirredonda con mangos bi-
materiales**



DETALLES DEL PRODUCTO

- Mangos ERGO™ bi-componentes: la superficie termoplástica suave en polipropileno resistente proporciona un agarre superior
- Desarrollado de acuerdo con el proceso científico ERGO™
- Capacidad de corte: 2.5 mm a 3 mm de Cu, 1.8 mm de Fe, 1.4 mm a 1.6 mm de Fe +
- Equipado con un muelle de retorno on-off patentado
- Mordazas dentadas y de forma semicircular para agarrar materiales planos y redondos con gran accesibilidad en espacios confinados
- Mordazas rectas, con bordes de corte endurecidos para cortar alambre blando y duro
- Aleación de alto rendimiento acero
- Acabado fosfatado, tratamiento anticorrosión
- Normas: ISO 5745
- IP = Embalaje industrial

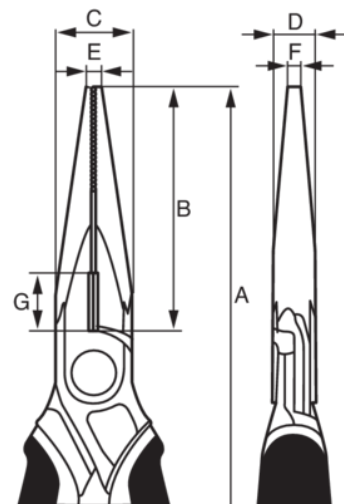





Follow the Fish!







ATRIBUTOS DE PRODUCTO





Producto: 2430 G-140

A	140 mm	B	37 mm	C	15 mm
D	7.8 mm	E	2.5 mm	F	2 mm
G	12 mm	 2.5 mm	 1.8 mm		
 1.4 mm	 120 g				





Producto: 2430 G-160

A	160 mm	B	51 mm	C	16.5 mm
D	8.8 mm	E	3 mm	F	2.5 mm
G	12 mm	 3.0 mm	 1.8 mm		
 1.6 mm	 160 g				





Producto: 2430 G-200

A	200 mm	B	72 mm	C	17 mm
D	9.3 mm	E	3 mm	F	2.5 mm
G	12 mm	 3.0 mm	 1.8 mm		
 1.6 mm	 170 g				





Producto: 2430 G-140 IP

A	140 mm	B	37 mm	C	15 mm
D	7.8 mm	E	2.5 mm	F	2 mm
G	12 mm	 2.5 mm	 1.8 mm		
 1.4 mm	 120 g				

Producto: 2430 G-160 IP

A	160 mm	B	51 mm	C	16.5 mm
D	8.8 mm	E	3 mm	F	2.5 mm
G	12 mm	 3.0 mm	 1.8 mm		
 1.6 mm	 160 g				

Producto: 2430 G-200 IP

A	200 mm	B	72 mm	C	17 mm
D	9.3 mm	E	3 mm	F	2.5 mm
G	12 mm	 3.0 mm	 1.8 mm		
 1.6 mm	 170 g				

